

Equipment Recognition

6-182

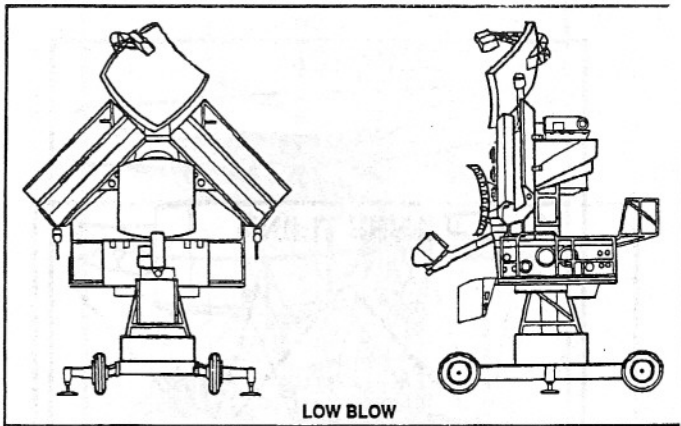

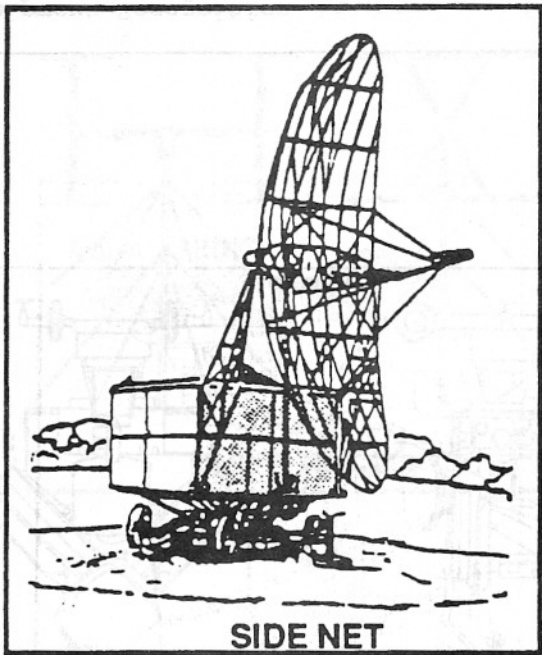

Equipment Recognition

6-184

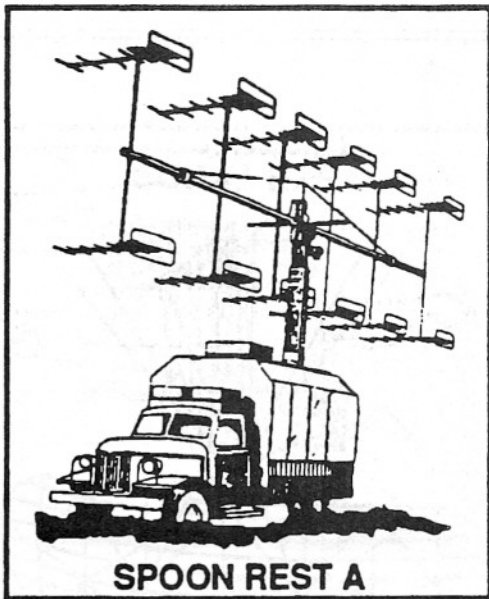



SQUAT EYE

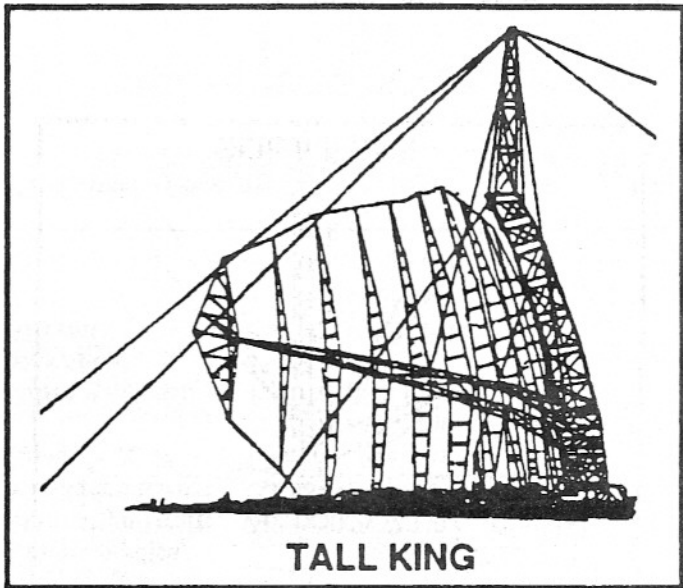

TALL KING

LINE DIAGRAM UNAVAILABLE

SOHO FF

Characteristics:

LOA/Beam/Draft: 242.1x50.9x12.1 ft

Missile launchers: 4xCSS-N-2 single tube SSM

Guns: 100mm single barrel
2x37,30, and 25mm twin barrel

Other weapons: 4xRBU-1200; mines; d.c.

Max speed: 23 kts

Aircraft: Platform for 1 medium helo.

Equipment Recognition

6-188



NAJIN FFL

Characteristics:

LOA/Beam/Draft:	335x33x10 ft
Missile launchers:	2xCSS-N-1 single tube SSM
Guns:	2x100mm single barrel 2x57,30, and 25mm twin barrel 4x14.5mm quad barrel
Other weapons:	4xRBU-1200; mines; d.c.
Max speed:	24.3 kts
Aircraft:	None

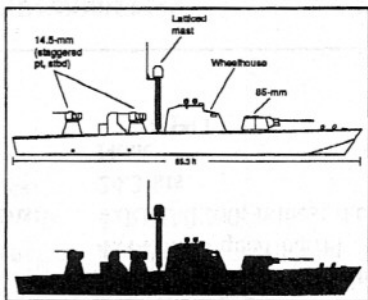

CHONGJIN PB

Characteristics:

LOA/Beam/Draft: 85.3x19x6.6 ft

Missile launchers: None

Guns: 85mm single barrel tank turret
2x14.5mm twin barrel

Other weapons: None

Max speed: 40 kts

Aircraft: None

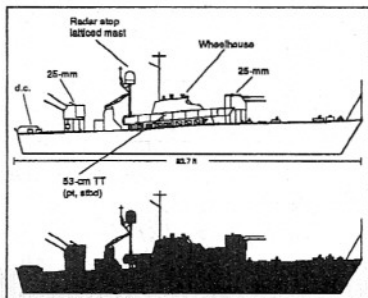

P-6 PB/PT

Characteristics:

LOA/Beam/Draft: 83.7x20.3x5.9 ft

Missile launchers: None

Guns: 2x25mm twin barrel or
2x14.5mm twin barrel

Other weapons: 2x53cm single torpedo tubes (PT)

Max speed: 43 kts

Aircraft: None

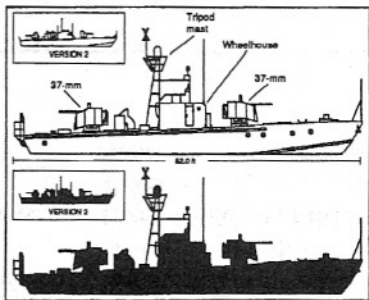

SHANTOU PB

Characteristics:

LOA/Beam/Draft: 82x17.4x6.9 ft

Missile launchers: None

Guns: 2x37mm twin barrel or
2x37mm single &
2x25mm twin barrel

Other weapons: None

Max speed: 24 kts

Aircraft: None

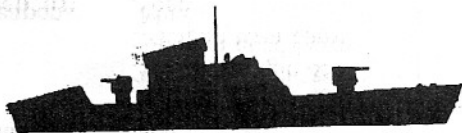
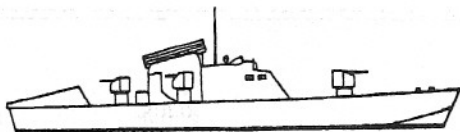

CHAHO PB

Characteristics:

LOA/Beam/Draft:	85.3x19x6.6 ft
Missile launchers:	None
Guns:	2x14.5mm twin barrel
Other weapons:	122mm (BM-21) MRL
Max speed:	40 kts
Aircraft:	None

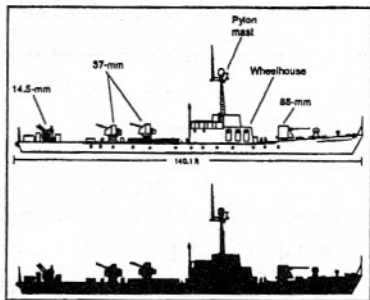

CHODO PC

Characteristics:

LOA/Beam/Draft: 140.1x19x6.2 ft
Missile launchers: None
Guns: 85mm single barrel
 2x37mm single &
 14.5mm quad barrel
Other weapons: Mines
Max speed: 20 kts
Aircraft: None

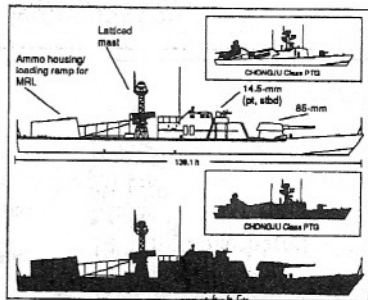

CHONGJU PC/PT/PTG/WPC

Characteristics:

- LOA/Beam/Draft:** 139.8x24x6.6 ft
- Missile launchers:** 4xCSS-N-1 single tube (PTG)
- Guns:** 85, 2x37, 25, & 14.5mm (PC/WPC)
2x30mm (PT/PTG)
- Other weapons:** 2 possible RBU-1200 (PC/WPC)
at least 2 torpedoes (PT)
- Max speed:** 22.5 kts
- Aircraft:** None

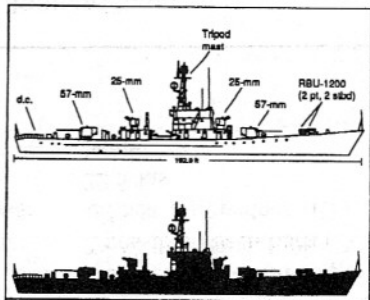

HAINAN PC

Characteristics:

LOA/Beam/Draft: 192.9x23.6x14.1 ft

Missile launchers: None

Guns: 2x57mm & 25mm twin barrel

Other weapons: 4xRBU-1200 5 tube launcher,
mines, d.c.

Max speed: 30.5 kts

Aircraft: None

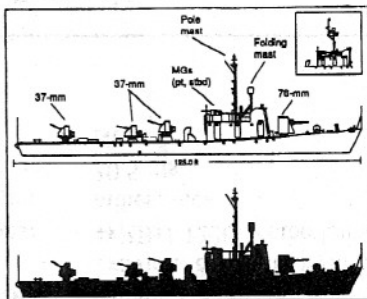

K-48 PC

Characteristics:

LOA/Beam/Draft:	125x18x5.6 ft
Missile launchers:	None
Guns:	76mm & 3x37mm single barrel 2x14.5mm twin barrel
Other weapons:	Mines
Max speed:	18 kts
Aircraft:	None

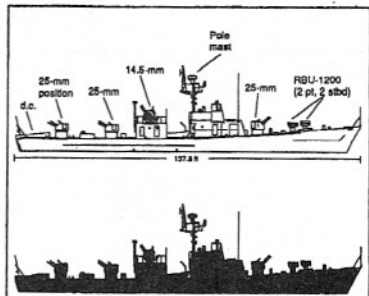

S.O. 1 PC

Characteristics:

LOA/Beam/Draft: 137.8x20x7.9 ft

Missile launchers: None

Guns: 100mm (one unit), 76mm single barrel
 3x25mm twin barrel
 14.5mm quad mount

Other weapons: 4xRBU-1200, mines, d.c.

Max speed: 28.5 kts

Aircraft: None

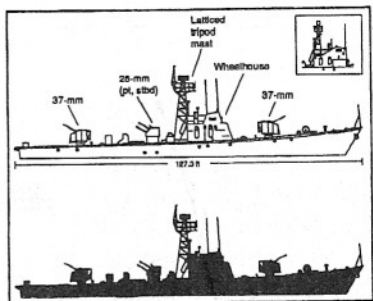

SHANGHAI II PC

Characteristics:

LOA/Beam/Draft: 127.3x17.7x5.3 ft

Missile launchers: None

Guns: 2x37 & 25mm twin barrel
At least one 82mm RR (on some)

Other weapons: Mines, d.c.

Max speed: 30 kts

Aircraft: None

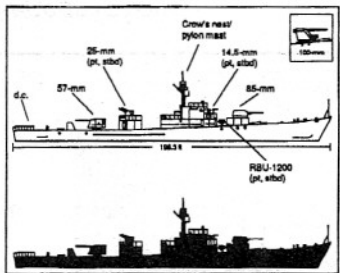

TAECHONG I/II PC

Characteristics:

LOA/Beam/Draft: 197.5 (I) 199.5 (II) x23.6x6.6 ft

Missile launchers: None

Guns: 100mm or 85mm single, &
25mm twin (I only)
57mm twin (I & II), 2x30mm
twin (II only), 14.5mm (I & II)

Other weapons: 2xRBU-1200 & mines (I only)
d.c. (I & II)

Max speed: 30 kts

Aircraft: None